

HF-430NEO Series **PROFIBUS for Communication option** **Model: P1-PB**

Operating and Maintenance Manual



NOTICE

1. Make sure that this operating and maintenance manual is delivered to the end user of inverter unit.
2. Read this manual before installing or operating the inverter unit, and store it in a safe place for reference.

Copyright © 2020 Sumitomo Heavy Industries, Ltd. All rights reserved.

All rights reserved. No part of this publication may be reproduced, stored in a retrieval system, or transmitted, in any form or by any means, mechanical, electronic, photocopying, recording, or otherwise, without the prior written permission of Sumitomo. No patent liability is assumed with respect to the use of the information contained herein. Moreover, because Sumitomo is constantly striving to improve its high-quality products, the information contained in this manual is subject to change without notice. Every precaution has been taken in the preparation of this manual. Sumitomo assumes no responsibility for errors or omissions. Neither is any liability assumed for damages resulting from the use of the information contained in this publication.

Introduction

Thank you for purchasing the P1-PB (Communication option for HF-430NEO series inverter) .
This instruction manual describes how to handle and maintain the P1-PB.

Please read this manual carefully before using the P1-PB, and keep it handy for those who operate, maintain and inspect it.

For the purpose of reducing paper consumption and provision of the latest information, we enclose the instruction manual only, while providing the User's Guide for more detailed description through electronic data instead of CD or printed document.

■ Instruction manual (this document)

The instruction manual provides the minimum information necessary for handling the product.

Please make sure to read the Instruction manual as well as the User's Guide for more detailed information.

■ User's Guide (P1-PB)

The User's Guide provides detailed information necessary for handling the product.

Please make sure to read User's Guide for proper use.

If future updated descriptions differ from the Basic Guide, the description in the User's Guide will have higher priority. Always use the P1-PB strictly within the range described in the User's Guide and perform proper inspection and maintenance to prevent failures or accidents.

The latest version of the User's guide can be obtained through our website.

■ Handling the inverter HF-430NEO

For handling the inverter, please make sure to read its Instruction manual and User's Guide.

■ For a proper use

Before using the inverter, please read carefully the inverter's Instruction manual and User's Guide, the P1-PB User's Guide and this manual.

In Addition any personnel handling or performing maintenance of the product must read carefully the inverter's Instruction manual and User's Guide, the P1-PB User's Guide and this manual.

Before any attempt to install, operate, maintain or inspect this equipment, a complete understanding of the equipment specifications, safety instructions, precautions, handling and operation instructions is required. Please follow all the specifications and instructions for a proper use. Additionally, periodically review the inverter's Instruction manual and User's Guide, the P1-PB User's Guide and this manual.

■ Precautions

It is prohibited to reproduce or reform this document partially or totally in any form without the publisher's permission.

The contents of the document are subject to change without prior notice.

Any handling, maintenance or operation method NOT described on the inverter's Instruction manual and User's Guide, the P1-PB User's Guide or this manual is not covered by the product warranty.

Please DO NOT perform any procedure NOT described on the HF-430NEO or the P1-PB manuals since it can be the cause of unexpected failures or accidents.

We are not responsible for any impact from operations regardless of unexpected failure or accident due to operation or handling of the product in a manner not specified on the inverter's Instruction manual and User's Guide, the P1-PB User's Guide or this manual. We appreciate your understanding.

Note that, in case the inverter's Instruction manual and User's Guide, the P1-PB User's Guide and this manual are enclosed, they should be delivered to the end user of the inverter. Also make sure to download and keep accessible any other related guides or instruction manuals for the end user.

Table of Contents

● Introduction	1
● Table of Contents	2
1. Precautions	
1.1 Please be Careful !	3
1.2 Precautions during the installation !	3
1.3 Precautions during the wiring !	4
1.4 Precautions during operation !	5
1.5 Precautions during Maintenance/Inspection !	6
1.6 Precautions for disposal !	6
1.7 Other Precautions !	6
2. The enclosed items	7
3. Verification after the purchase	7
4. Product Inquiry	7
5. External Features	8
6. Name plate	8
7. Installation	
7.1 Installation	8
7.2 How to install	9
8. Connection	11
9. GSD File	11
10. Device specifications	12
11. Dimensions after installed	13
12. Registered Trademark	13
● Warranty	APP.1-1

1. Precautions

1.1 Please be Careful !





 **Caution** · If handled incorrectly or improperly, it might cause death, serious physical injuries, or damage to the inverter, motor or even the entire system.

 **Do** · Before installation, wiring, operation, inspection, or usage please read and fully understand this guide.

 **Caution** · There will be additional warnings about hazards and failure causes in other chapters.

 **Do** · Before installation, wiring, operation, inspection, or usage please read and fully understand this guide.

 **Caution** · In order to explain this device details the illustrations in this guide might show this device without covers.

 **Do** · Before operating this device please return all the covers to the original position, and follow all the necessary regulations and instructions written in this guide.

1.2 Precautions during the installation!





 **● Risk of Fire !**

 **Fire Hazard** · DO NOT place inflammable objects nearby.

 **Fire Hazard** · DO NOT let scraps of wire, welding sputtering, irons scraps or other objects get inside the device.

 **Prohibited** · Avoid installing this device in places with high temperature, high humidity, Condensation-prone conditions, dusty conditions, corrosive gas, explosive gas, flammable gas, grinding fluid mist, hydrogen sulfide or salt damage prone conditions. Additionally, it is recommended to install this device in ventilated room not exposed to direct sunlight.

 **Do**

 **● Risk of Injury !**

 **Injury**

 **Prohibited** · DO NOT install or operate products with damage or missing parts.

 **● Risk of an Inverter failure !**

 **Failure** · This device is a precision equipment, do not drop it, or give it a strong shock.

 **Failure** · DO NOT get on (step on) or place heavy objects on this device.

 **Do** · When handling the object, avoid places prone to static electricity(like carpets).

 **Do** · Since the human body can get charged with static electricity, as a safety measure please touch a safe metallic surface before handling this device.

1.3 Precautions during the wiring!

Danger



Electric shock and Fire hazard

● Risk of an electric shock and/or fire !

- Be sure to ground the inverter.
- Entrust the wiring work only to a qualified electrician.
- Before the wiring work make sure to turn off the power supply and wait for more than 10 or 15 minutes depending on the inverter model *.



Do

(Confirm that the charge lamp is OFF and the DC voltage between terminals P and N is 45 V or less.)

* For HF4322-5A5 to HF4322-022, HF4324-5A5 to HF4324-022 models the wait time is 15 minutes.

For HF4322-030 to HF4322-055, HF4324-030 to HF4324-055 models the wait time is 15 minutes.



Failure



Prohibited

● Risk of inverter failure !

- DO NOT pull any wire after wiring.



Electric shock and injury



Do

● Risk of an electric shock and/or injury !

- Perform the wiring only after installing the inverter.

Warning



Electric shock and injury

● Risk of an electric shock and/or injury !

- DO NOT operate/switch any of the switches from the 4 pole DIP switch on this device. When this device is shipped all switches are turned off.
- If any of the switches from the 4 pole DIP switch is operated/switched, this device will not work as intended and it might be the cause of failure.



Do

- Please handle the cables properly and do not let them get damaged. Using damaged cables will not only interfere with the correct operation of this device but also might be the cause of a system failure.



Fire hazard

● Risk of Fire !

- Please tighten the screws and bolts with the specified torque. (Please refer to the inverter user's guide.)
- Verify that none of the screws and bolts are loose.



Do

- Make sure that the inverter and this device are fixed together with the securing screw.
- Make sure that the connectors are properly fixed.

1.4 Precautions during operation!

Danger



Electric shock and Fire hazard

● Risk of an electric shock or fire !

· DO NOT touch the inside of this device, check the signal, do any wiring or plug/unplug the connectors while it energized.



Prohibited

· DO NOT insert any sick or rod like objects inside this device while it is energized.



Injury and Fire hazard

● Risk of an injury and/or fire !

· DO NOT touch the inside of this device or the inverter while they are energized



Prohibited



Electric shock

● Risk of an electric shock !

· Make sure to fasten all the screws of this device before turning it on. DO NOT detach this device while it is energized or the inverter capacitors are still charged. Additionally, do not touch the inverter while the inverter capacitors are still charged.



Prohibited



Do

· DO NOT touch this device with wet hands.

Warning



Injury or device Damage

● Risk of an injury and/or device damage !

· By using this device it becomes easier to change the settings and the output frequency of the inverter. When changing the settings or the output frequency of the inverter please make sure that it is within the supported range by the motor and/or the equipment.



Do

· In case this device is being used to make the inverter produce high frequency outputs for the gear motor, make sure that the gear can tolerate the high frequency output given by the inverter.

· During operation verify the motor rotation direction, and that there are no irregular sounds or vibrations

1.5 Precautions during Maintenance /Inspection!



Electric shock

● Risk of an electric shock !

· Before any maintenance or inspection make sure to turn off the power supply and wait for more than 10 or 15 minutes depending on the inverter model *.



Do

(Confirm that the charge lamp is OFF and the DC voltage between terminals P and N is 45 V or less.)



Prohibited

· Entrust the maintenance, inspection and/or part replacement only to a specialized personnel. (Be sure to remove wristwatches and metal accessories, e.g., bracelets, before maintenance and inspection work and use insulated tools for the work.)

*For HF4322-5A5 to HF4322-022, HF4324-5A5 to HF4324-022 models the wait time is 10 minutes.
For HF4322-030 to HF4322-055, HF4324-030 to HF4324-055 models the wait time is 15 minutes.

1.6 Precautions for disposal !



Injury and explosion hazard

● Risk of an injury and/or an explosion !

· Outsource to a qualified industrial waste disposal contractor when discarding this device. Disposing of this device on your own may result in the production of poisonous gas.



Do

· A qualified waste disposer includes industrial waste collector/transporter and industrial waste disposal operator. Follow all laws and decrees related to procedures of waste management and public cleansing when disposing of this device.

1.7 Other Precautions



Electric shock injury and Fire hazard

● Risk of an injury, an electric shock and/or fire !

· DO NOT modify this device



Prohibited

* In addition to the precautions described above, there are other precautions described in the chapter 8 of HF-430NEO user's guide. Please read and follow those precautions as well.

2. The enclosed items

- Enclosed items

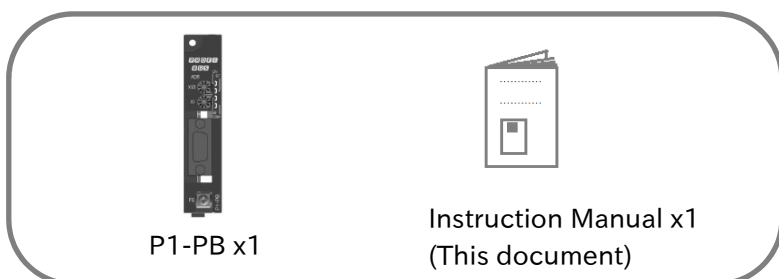

3. Verification after the purchase

- Please verify the following items when unpacking.
- In case there is any doubt or trouble with the product, please contact your sales agent as soon as possible.

Check that the items were not smashed or damaged during the delivery.

Check that there is a P1-PB, there is an Instruction Manual, when unpacking.

Please check again that your order match with the name plate of the device.

4. Product Inquiry

For an inquiry about product damage or faults or a question about the product, notify your supplier. When contacting the technical service, please provide the following information

- (1) Inverter model
- (2) Inverter manufacture number (MFG No.)
- (3) Option device model (P1-PB)
- (4) P1-PB manufacture number (MFG No.)
- (5) Date of purchase
- (6) Inquiry contents

For information about how to check the inverter model and the manufacture number (MFG No.) please refer to HF-430NEO user's manual.

For information about how to check the P1-PB model and the manufacture number (MFG No.) please refer to the section 6.

Furthermore, if the inquiry is about a P1-PB communication problem please provide us with the following additional information.

- (7) Current problem or abnormality
- (8) Frequency of occurrence
- (9) The PROFIBUS master being used
- (10) The PROFIBUS network configuration
- (11) A packet capture when the problem occurs

For further information regarding the packet capture please refer to the chapter 11 section 3 “P1-PB troubleshooting” of the User's Guide.

5. External Features

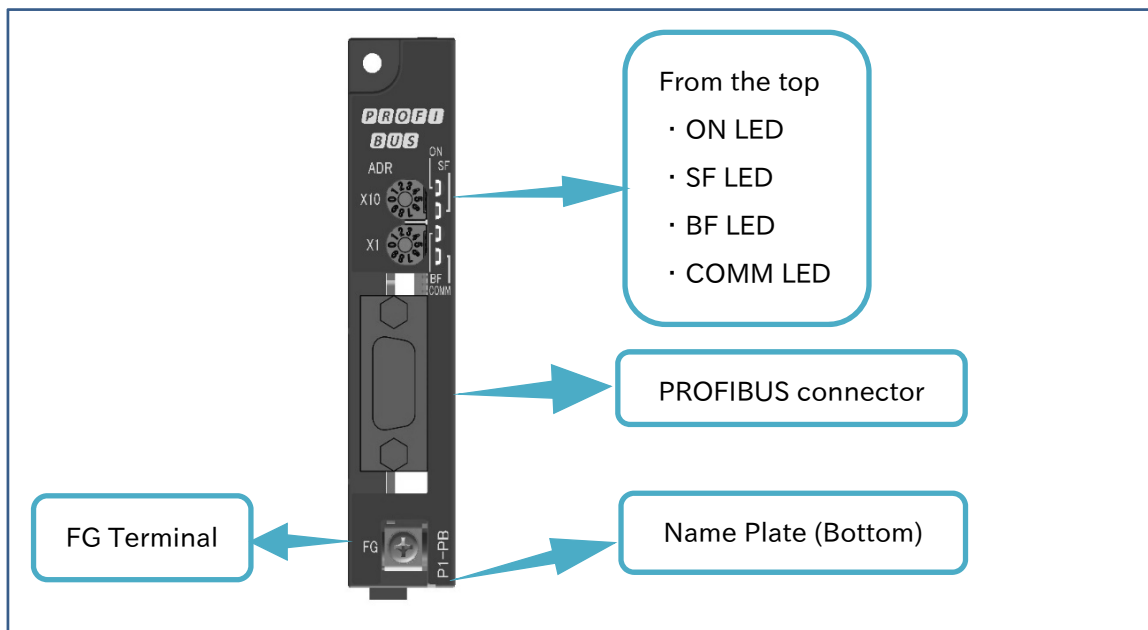

6. Name plate

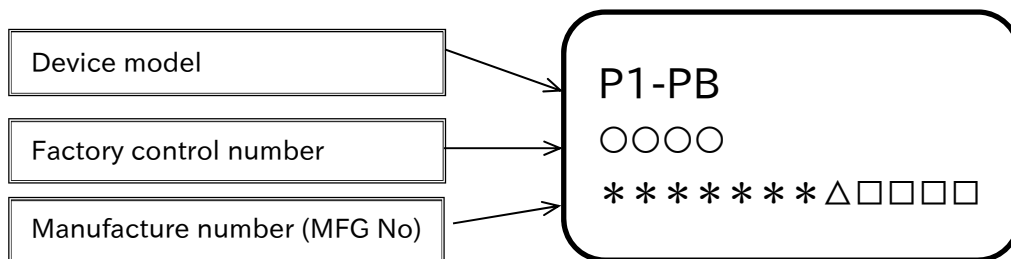

7. Installation

7.1 Installation

The P1-PB can be attached to any of the 3 option slots of the HF-430NEO inverter.

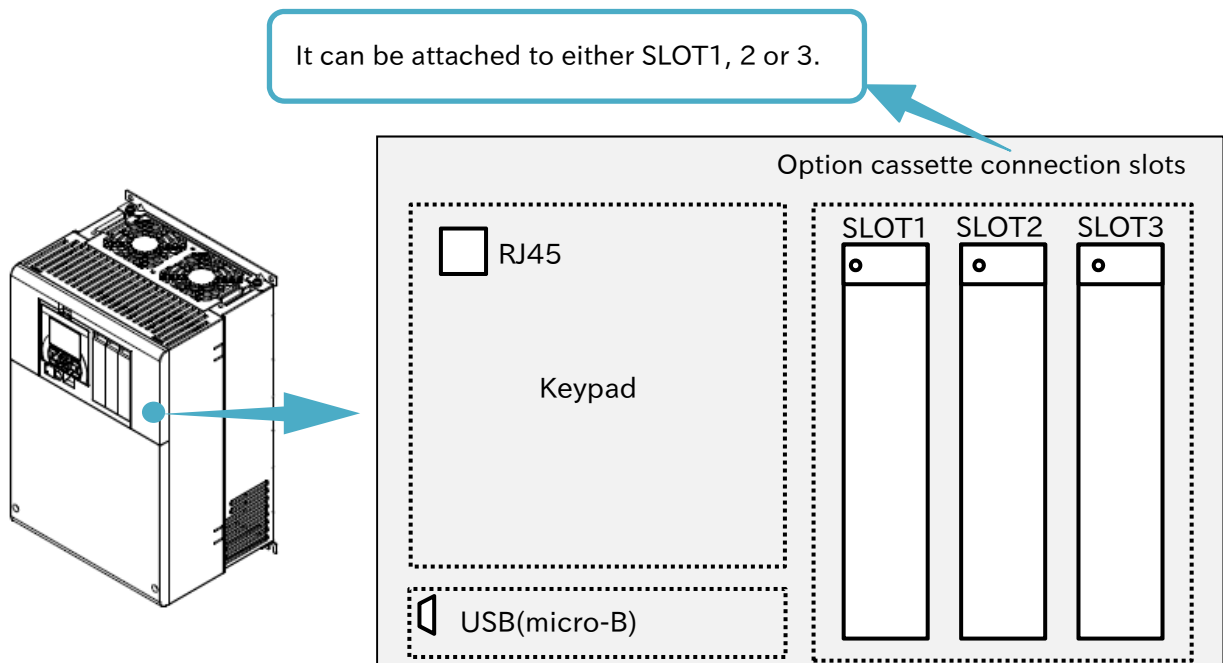

7.2 How to install

Before installing the P1-PB, please refer to the chapter 7 “Inverter setting” of the user's guide and configure the inverter.

For explanation purposes, it will be assumed that the P1-PB is going to be installed in the SLOT1.

- (1) Remove the cover of the option cassette connection slot.

Despite the removed cover will no longer be needed, it is recommended to keep it in a safe place. However the screw that secured the cover will be used to secure the P1-PB.

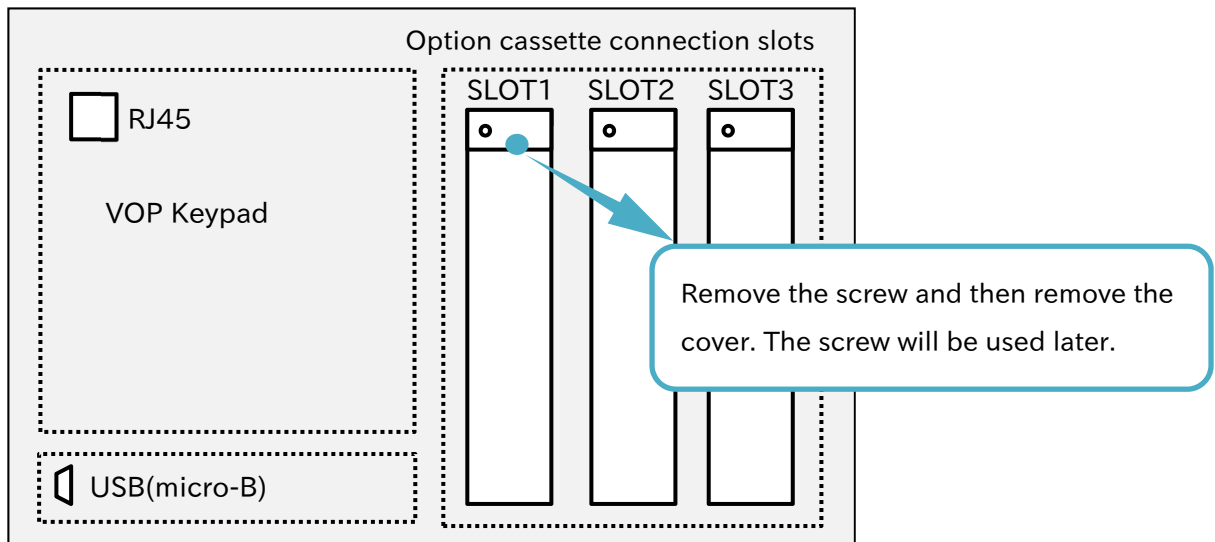

- (2) Attach the P1-PB. The slots 2 and 3 have one more connection in the lower side. However, the P1-PB will not need that connection.

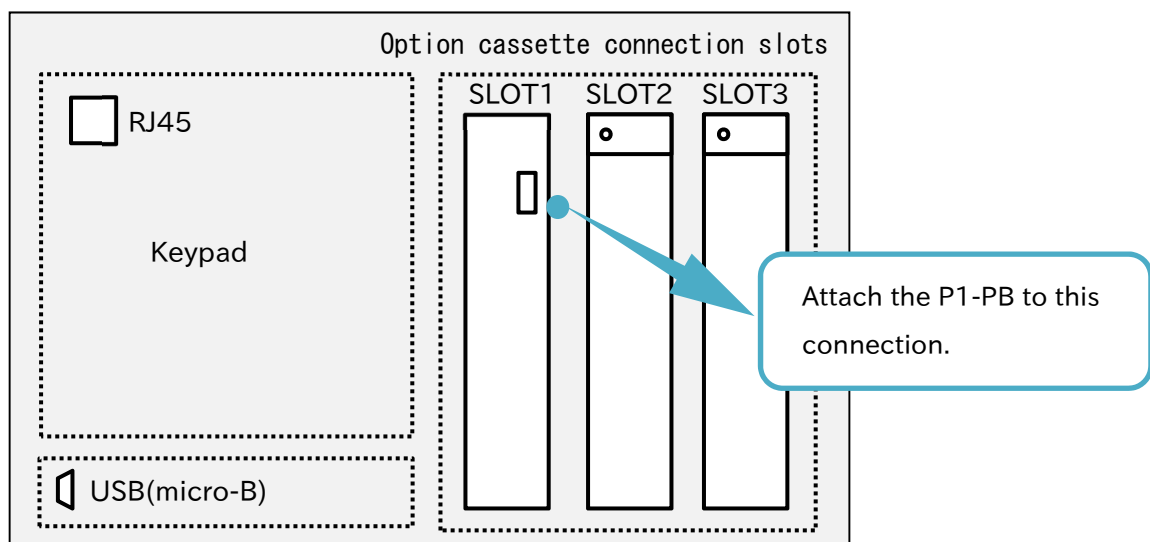

(3) Secure the P1-PB with the screw removed in (1)

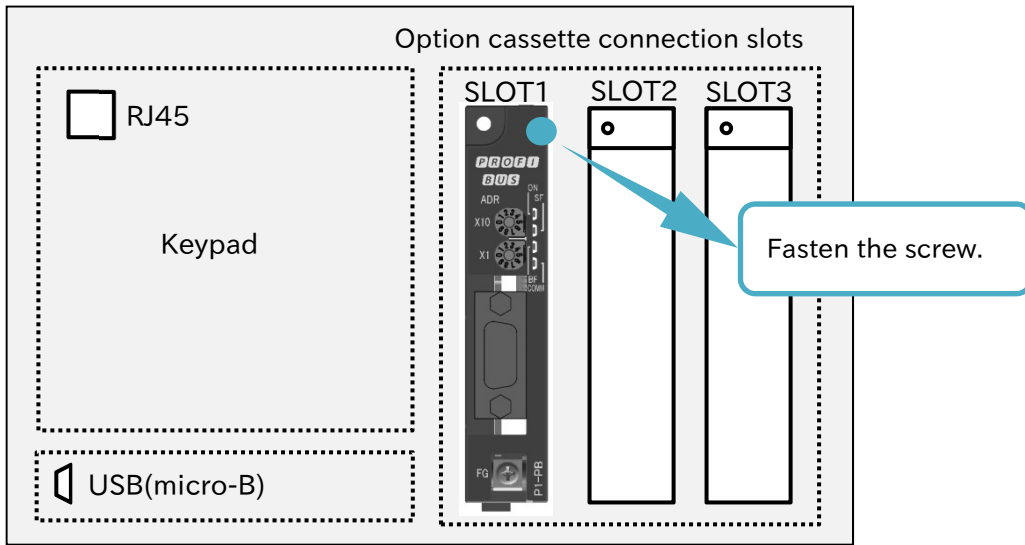

(4) Connect the FG terminal to functional ground.

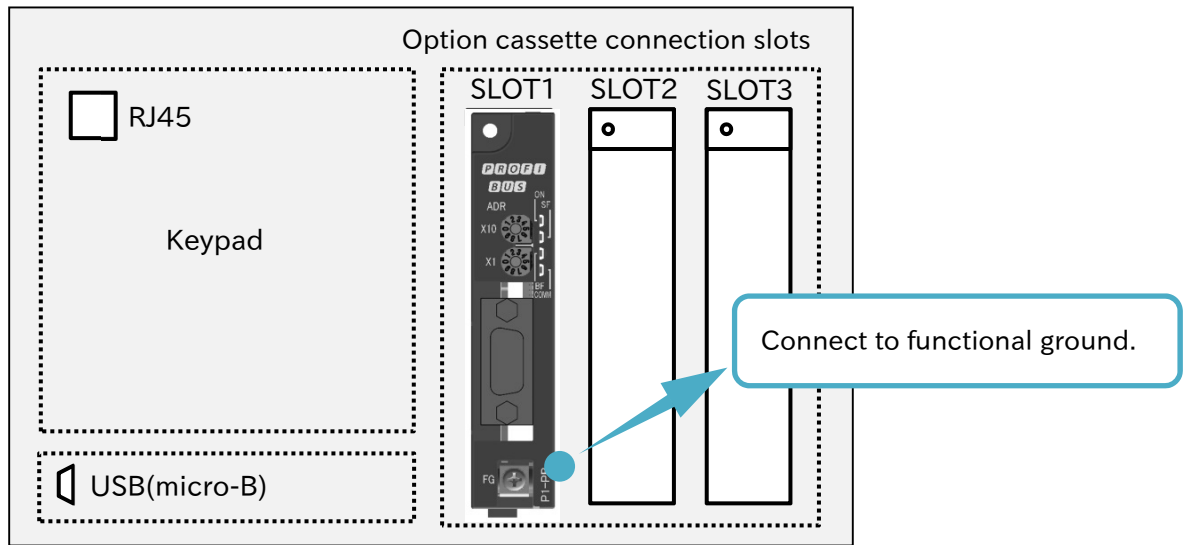

8. Connection

- Make sure that the communication line and the power line are placed as far as possible from each other. If they are placed close to each other, the communication line will pick up noise from the power line that can interfere with the transmission.
- Make sure to set up the system, so that in an event of a network failure, the inverter output stops immediately.

- (1) In case the master detects an abnormality in the connection, shut down the inverter primary power supply.
- (2) Allocate functions such as “free run” or “reset” to the inverter input terminals.
Accordingly, please turn on these terminals when the master detects a connection abnormality.
- (3) Configure the inverter in a way that it stops, free run stops or trip in case of a connection abnormality.
(When the operation command is received through PROFIBUS, the inverter shipment settings are configured so that if there is any abnormality in the connection the inverter will immediately stop)

For other information concerning the installation, please refer to the inverter user's guide.

Connect the communication cable (PROFIBUS cable), so it minimizes the tension and stress over the connector.

9. GSD File

In order to use the P1-PB, it is necessary to install the P1-PB GSD file into the PROFIBUS master configuration tool.

The GSD file is an xml file that has the specific information of the PROFIBUS slave device.

The GSD file can be obtained through our website. In case is not available or cannot be downloaded please contact the nearest sales office.

10. Device specifications

■ Specifications

Item		Specifications
Model		P1-PB
Weight		170g
Environment	Ambient operating temperature	-10~50°C
	Ambient operating humidity	20~90%RH
	Storage temperature	-20~65°C
	Vibration resistance	5.9m/s ² (0.6G)、10~55Hz
	Conformance to EMC and electrical safety standards	IEC/EN61800-3 Second environment, Category C3 IEC/EN61800-5-1 SELV
	Enclosure type	IP00
PROFIBUS Interface	Communications protocol	PROFIBUS DPV0 PROFIBUS DPV1
	Connector	D-sub 9 pin
	Cable	PROFIBUS DP cable
	Node address *	From 0 to 99 : set by rotary switches From 1 to 126 : set by oH-20 of HF-430NEO paramters
	Profile	PROFIdrive
PROFIdrive	PROFIdrive version	4.2
	Application class	AC1 (Standard Drive)
	Telegram	Standard telegram 1 P1-PB telegram 103 (PPO3 of PROFIdrive version 2) P1-PB telegram 104 (PPO4 of PROFIdrive version 2) P1-PB telegram 105 (like PPO5 of PROFIdrive version 2)
	Configuring of telegram	oH-24 and From oJ-01 to oJ-60 of HF-430NEO parameters
	Operating mode	Speed control mode
	Jogging	Only jogging 1 is supported.

*When you set the rotary switches within the range from 01 to 99, the value is addressed.

When you set the rotary switches 00 and oH-20 is within the range from 1 to 125, the value of oH-20 is addressed. Otherwise 126 is addressed.

11. Dimensions after installed

The dimensions of the P1-PB after it is installed on HF-430NEO are shown in the image below. As shown on the image a part of this device will stand out from HF-430NEO. Please be cautious when installing the device.

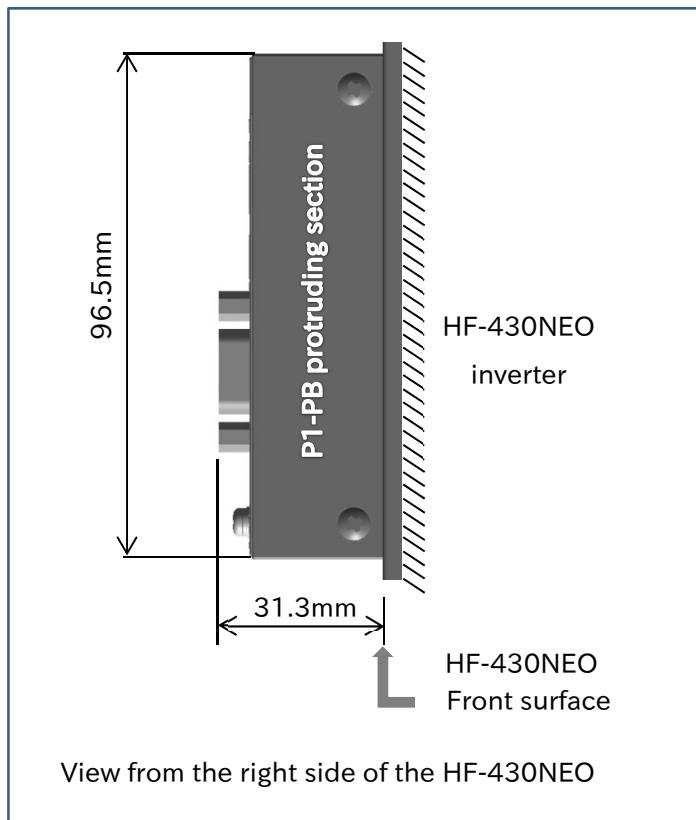

12. Registered Trademark

PROFIBUS® is trade names of the non-profit organization PROFIBUS Nutzerorganisation e.V.(PNO).

Warranty

Warranty

Warranty period	The warranty shall be 18 months from date of shipment or 12 months after initial operation, whichever is shorter.
Warranty condition	In the event that any problem or damage to the Product arises during the "Warranty Period" from defects in the Product whenever the Product is properly installed and combined with the Buyer's equipment or machines maintained as specified in the maintenance manual, and properly operated under the conditions described in the catalog or as otherwise agreed upon in writing between the Seller and Buyer or its customers; the Seller will provide, at its sole discretion, appropriate repair or replacement of the Product without charge at a designated facility, except as stipulated in the "Warranty Exclusions" as described below. However, if the Product is installed or integrated into the Buyer's equipment or machines, the Seller shall not reimburse the cost of: removal or re-installation of the Product or other incidental costs related thereto, any lost opportunity, any profit loss or other incidental or consequential losses or damages incurred by the Buyer or its customers.
Warranty exclusion	Notwithstanding the above warranty, the warranty as set forth herein shall not apply to any problem or damage to the Product that is caused by: <ol style="list-style-type: none"> 1. Installation, connection, combination or integration of the Product in or to the other equipment or machine that rendered by any person or entity other than the Seller. 2. Insufficient maintenance or improper operation by the Buyer or its customers such that the Product is not maintained in accordance with the maintenance manual provided or designated by the Seller; 3. Improper use or operation of the Product by the Buyer or its customers that is not informed to the Seller, including, without limitation, the Buyer's or its customers' operation of the Product not in conformity with the specifications; 4. Any problem or damage on any equipment or machine to which the Product is installed, connected or combined or any specifications particular to the buyer or its customers; 5. Any changes, modifications, improvements or alterations to the Product or those functions that are rendered on the Product by any person or entity other than the Seller; 6. Any parts in the Product that are supplied or designated by the Buyer or its customers; 7. Earthquake, fire, flood, salt air, gas, lightning, acts of God or any other reasons beyond the control of the Seller; 8. Normal wear and tear, or deterioration of the Product's parts, such as the cooling fan bearings; 9. Any other troubles, problems or damage to the Product that are not attributable to the Seller.
Others	The Seller will not be responsibility for the installation and removal of the inverter. Any inverter transportation cost shall be born by both Seller and Buyer.

Worldwide Locations

- U.S.A**
Sumitomo Machinery Corporation of America (SMA)
1453 Cornwall Blvd. Chesapeake, VA 23323, U.S.A.
TEL (1)757-485-3355 FAX (1)757-485-7490
- Canada**
SM Cyclo of Canada, Ltd. (SMC)
1200 Cornwall Road, Oakville, Canada ON L6J 7T5
TEL (1)905-469-1050 FAX (1)905-469-1055
- Mexico**
SM Cyclo de Mexico, S.A. de C.V. (SMME)
Av. Desarrollo 541, Col. Finsa, Guadalupe, Nuevo León, México, CP67132
TEL (52)81-8144-5130 FAX (52)81-8144-5130
- Brazil**
Sumitomo Industrias Pesadas do Brasil Ltda. (SHIB)
Rodovia do Acucar (SP-075) Km 26
Itu, Sao Paulo, Brasil
TEL (55)11-4886-1000 FAX (55)11-4886-1000
- Chile**
SM-Cyclo de Chile Ltda. (SMCH)
Camino Lo Echevers 550, Bodegas 5 y 6, Quilicura, Región Metropolitana, Chile
TEL (56)2-892-7000 FAX (56)2-892-7001
- Argentina**
SM-Cyclo de Argentina S.A. (SMAR)
Ing Delpini 2230, B1615KGB Grand Bourg, Malvinas Argentinas, Buenos Aires, Argentina
TEL (54)3327-45-4095 FAX (54)3327-45-4099
- Guatemala**
SM Cyclo de Guatemala Ensambladora, Ltda. (SMGT)
Parque Industrial Unisur, 0 Calle B 19-50 Zona 3, Bodega D-1 Delta Bárcenas en Villa Nueva, Guatemala
TEL (502)6648-0500 FAX (502)6631-9171
- Colombia**
SM Cyclo Colombia, S.A.S. (SMCO)
Parque Industrial Celta, Km 7.0 Autopista Medellín, Costado Occidental, Funza, Cundinamarca, Colombia
TEL (57)1-826-9766
- Peru**
SM Cyclo de Perú, S.A.C (SMPE)
Jr. Monte Rosa 255, Oficina 702, Lima, Santiago de Surco, Perú
TEL (51)1-713-0342 FAX (51)1-715-0223
- Germany**
Sumitomo (SHI) Cyclo Drive Germany GmbH (SCG)
Cyclostraße 92, 85229 Markt Indersdorf, Germany
TEL (49)8136-66-0 FAX (49)8136-5771
- Austria**
Sumitomo (SHI) Cyclo Drive Germany GmbH (SCG)
SCG Branch Austria Office
Grüntalerstraße 30A, 4020 Linz, Austria
TEL (43)732-330958 FAX (43)732-331978
- Belgium**
Hansen Industrial Transmissions NV (HIT)
Leonardo da Vincilaan 1, Edegem, Belgium
TEL (32)34-50-12-11 FAX (32)34-50-12-20
- France**
SM-Cyclo France SAS (SMFR)
8 Avenue Christian Doppler, 77700 Serris, France
TEL (33)164171717 FAX (33)164171718
- Italy**
SM-Cyclo Italy Srl (SMIT)
Via dell' Artigianato 23, 20010 Cornaredo (MI), Italy
TEL (39)293-481101 FAX (39)293-481103
- Spain**
SM-Cyclo Iberia, S.L.U. (SMIB)
C/Gran Via Nº 63 Bis, Planta 1, Departamento 1B
48011 Bilbao-Vizcaya, Spain
TEL (34)9448-05389 FAX (34)9448-01550
- United Kingdom**
SM-Cyclo UK Ltd. (SMUK)
Unit 29, Bergen Way, Sutton Fields Industrial Estate, Kingston upon Hull, HU7 0YQ, East Yorkshire, United Kingdom
TEL (44)1482-790340 FAX (44)1482-790321
- Turkey**
SM Cyclo Turkey Güç Aktarım Sis. Tic. Ltd. Sti. (SMTR)
Barbaros Mh. Çiğdem Sk. Ağaoğlu, Office Mrk. No:1 Kat:4 D.18
Ataşehir, İstanbul, Turkey
TEL (90)216-250-6069 FAX (90)216-250-5556
- India**
Sumi-Cyclo Drive India Private Limited (SDI)
Gat No. 186, Raison Industrial Park, Alandi Markal Road, Fulgaon-Pune, Maharashtra, India
TEL (91)96-0774-5353
- China**
Sumitomo (SHI) Cyclo Drive China, Ltd. (SCT)
11F, SMEG Plaza, No. 1386 Hongqiao Road, Changning District, Shanghai, China (P.C. 200336)
TEL (86)21-3462-7877 FAX (86)21-3462-7922
- Hong Kong**
SM-Cyclo of Hong Kong Co., Ltd. (SMHK)
Rm 1301, CEO Tower, 77 Wing Hong Street, Cheung Sha Wan, Kowloon, Hong Kong
TEL (852)2460-1881 FAX (852)2460-1882
- Korea**
Sumitomo (SHI) Cyclo Drive Korea, Ltd. (SCK)
Royal Bldg. 19 Rm. 913, 5 Saemunan-ro 5-Gil Jongro-Gu Seoul, Korea 03173
TEL (82)2-730-0151 FAX (82)2-730-0156
- Taiwan**
Tatung SM-Cyclo Co., Ltd. (TSC)
22 Chungshan N. Road 3rd., Sec. Taipei, Taiwan 104, R.O.C.
TEL (886)2-2595-7275 FAX (886)2-2595-5594
- Singapore**
Sumitomo (SHI) Cyclo Drive Asia Pacific Pte. Ltd. (SCA)
15 Kwong Min Road, Singapore 628718
TEL (65)6591-7800 FAX (65)6863-4238
- Philippines**
Sumitomo (SHI) Cyclo Drive Asia Pacific Pte. Ltd. Philippines Branch Office (SMPH)
C4 & C5 Buildings Granville Industrial Complex, Carmona, Cavite 4116, Philippines
TEL (63)2-584-4921 FAX (63)2-584-4922
- Vietnam**
SM-Cyclo (Vietnam) Co., Ltd. (SMVN)
Factory 2B, Lot K1-2-5, Road No. 2-3-5A, Le Minh Xuan Industrial Park, Binh Chanh Dist., HCMC, Vietnam
TEL (84)8-3766-3709 FAX (84)8-3766-3710
- Malaysia**
SM-Cyclo (Malaysia) Sdn. Bhd. (SMMA)
No.7C, Jalan Anggerik Mokara 31/56, Kota Kemuning, Seksyen 31, 40460 Shah Alam, Selangor Darul Ehsan, Malaysia
TEL (60)3-5121-0455 FAX (60)3-5121-0578
- Indonesia**
PT. SM-Cyclo Indonesia (SMID)
Jalan Sungkai Blok F 25 No. 09 K, Delta Silicon III, Lippo Cikarang, Bekasi 17530, Indonesia
TEL (62)21-2961-2100 FAX (62)21-2961-2211
- Thailand**
SM-Cyclo (Thailand) Co., Ltd. (SMTH)
195 Empire Tower, Unit 2103-4, 21st Floor, South Sathorn Road, Yannawa, Sathorn, Bangkok 10120, Thailand
TEL (66)2670-0998 FAX (66)2670-0999
- Australia**
Sumitomo (SHI) Hansen Australia Pty. Ltd. (SHAU)
181 Power St, Glendenning, NSW 2761, Australia
TEL (61)2-9208-3000 FAX (61)2-9208-3050
- Japan**
Sumitomo Heavy Industries, Ltd. (SHI)
ThinkPark Tower, 1-1 Osaki 2-chome, Shinagawa-ku, Tokyo 141-6025, Japan
TEL (81)3-6737-2511 FAX (81)3-6866-5160

Specifications, dimensions, and other items are subject to change without prior notice.



Power Transmission & Controls Group

Headquarter ThinkPark Tower, 1-1 Osaki 2-chome, Shinagawa-ku, Tokyo 141-6025, Japan

No.DM3405E-1.0

EA10 Printed 2020.01